



# Technical Manual

## Glow545-CT Three-Phase CT Connected Meter



© Copyright 2025  
Hildebrand Technology Limited  
63 Dean Street  
London W1D 3QG  
UK

[www.hildebrand.co.uk](http://www.hildebrand.co.uk)

The meter user manual is intended for technically qualified personnel of energy supply companies responsible for the meter planning, installation, operation and maintenance.

The user manual contains all the information required for application of the meters for the intended purpose. This includes:

- Provision of knowledge concerning characteristics, construction and function of the meter
- Information about possible dangers, their consequences and measures to prevent any danger
- Details concerning the performance of all work throughout the service life of the meter

## 1. Meter Installation and Wiring

---

### 1.1. Introduction

Glow545-CT meter is designed for transformer connection application. The meter is equipped with several communication port, it has a remote communication cabin, which is using LTE-M/NB-IoT/GPRS/WIFI communication modem for AMI system. The flexible but most useful design, extended functionality and highest precision metering accuracy enables customers to meet these new requirements successfully.

#### 1.1.1. Measuring and time of use

High measurement accuracy that meets MID standards.

Measurement of active (kWh), reactive (kVARh), total/separated energy registers for import and export

- 6-months of history energy records for utility analysis
- Up to four tariffs per day and custom billing cycles (optional)
- Precision internal real time clock (RTC) with backup long-life Li-battery
- Instantaneous per phase values of voltage, current and power factor (optional)

#### 1.1.2. Advanced features and functions

- Polycarbonate case and IP54 protection
- Non-volatile memory for energy data
- Instant kW power consumption bar indicated
- Back light display, with 8 digits LCD easy to read
- 3 decimal fractions in test mode for energy detection
- Low self-consumption and long-life operation

#### 1.1.3. Security and temper-proof

- Reverse energy flow detection with LCD alarm indicated
- Immune to external magnetic interference, alarm in the display when detect the interference
- Independent sealing of the meter body and terminal cover.
- Multiple level password permission of meter program



### 1.4. Detailed Connection Diagram

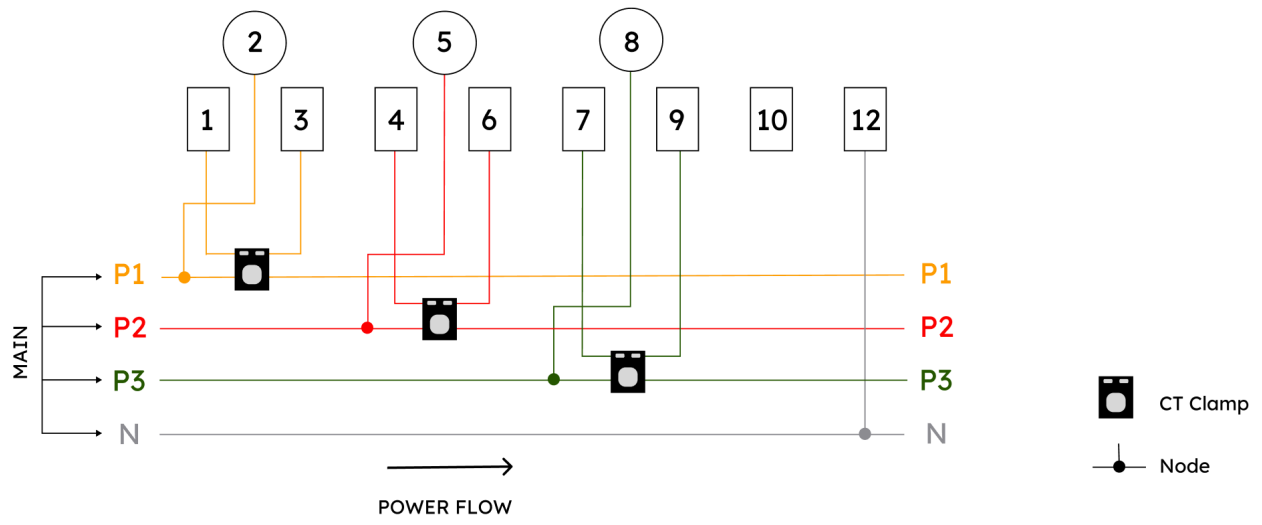

## 2. Meter Functionality

### 2.1. Function and performance specification

Item	Sub-Item	Parameter
<b>Basic Parameters</b>	Meter type	3P4W
	Active accuracy class	CT meter: Class B (EN 50470-3) or Class C
	Nominal voltage	3P4W meter: 3x 230/400 V Operating voltage: 0.8Un~1.12Un
	Nominal frequency	50Hz +/-2%
	Current specification	CT meter: 5(10)A
	Starting current	CT meter: 0.002Ib
	Pulse constant	CT meter: 10000imp/kWh, 10000imp/kvarh
	Power consumption	Current circuit: active power consumption<0.5VA Voltage circuit: active consumption<2.0W, apparent power consumption<5VA
	Operating temperature range	-40°C ~ +70°C
	Storage temperature range	-40°C ~ +70°C
	Humidity range	5%~95%RH
Waterproof and dustproof level	IP51	
<b>Special Test Type</b>	Pulse voltage	6kV
<b>Communication</b>	Communication protocol	Near-infrared: IEC62056-21 E mode RS485: HDLC DLMS/COSEM NB-IoT/LTE-M/2G/WiFi: TCP DLMS/COSEM
	Communication port	One near-infrared communication port, 300-9600bps One RS485 port, 9600bps One NB-IoT/LTE-M/2G/WiFi port, 9600-19200bps
<b>Metering</b>	Active energy	Import active energy (1-0.1.8.0.255) = +A1 + +A2 + +A3  Or, = +A1 + +A2 + +A3  +  A1 + -A2 + -A3  Export reactive energy (10.2.8.0.255) = -A1 + -A2 + -A3

	Reactive energy	<p>Import reactive energy (1-0.3.8.0.255)  <math>+R= +Ri + +Rc </math>                      Export reactive energy (1-0.4.8.0.255)  <math>-R= -Ri + -Rc </math>                      (+Ri: reactive quadrant 1                      +Rc:reactive quadrant 2                      -Ri: reactive quadrant 3                      -Rc: reactive quadrant 4)</p>
	Reactive energy of 4 quadrant	Reactive energy of quadrant: I, II, III, IV
	Absolute energy	Absolute active energy (1-0.15.8.0.255) $= +A1 + +A2 + +A3 + -A1 + -A2 + -A3 $
	Apparent energy	<p>Import apparent energy (1-0.9.8.0.255)  <math>= +A1 + +A2 + +A3 </math> Or,  <math>= +A1 + +A2 + +A3 + -A1 + -A2 + -A3 </math> Export                      apparent energy (1-0.10.8.0.255)  <math>= -A1 + -A2 + -A3 </math></p>
	Split-phase energy	<p>A/B/C Import active energy (1-0.21/41/61.8.0.255)  <math>= +A </math> or <math> +A + -A </math>                      A/B/C Export active energy (1-0.22/42/62.8.0.255)  <math>= -A </math>, A/B/C Import reactive energy                      (1-0.23/43/63.8.0.255)  <math>+R= +Ri + +Rc </math>                      A/B/C Export reactive energy                      (1-0.24/44/64.8.0.255)  <math>-R= -Ri + -Rc </math></p>
	Instantaneous values	<p>Voltage (A/B/C)                      Current (A/B/C)                      Power factor (total/ A/B/C)                      Active power (total/ A/B/C)                      Export active power(A/B/C)                      Reactive power (Total/ A/B/C)                      Export reactive power(A/B/C)                      Apparent power (Total/ A/B/C)                      Power grid frequency                      Voltage angle (AB/AC)                      Voltage and current angle (A/B/C)</p>
<b>LED and LCD Display</b>	LED indicator	One active pulse output, one reactive pulse output, one alarm light

	LCD indicator	Electricity display mode: 5+3/6+2/7+1/8+0 configurable, decimals of power off is the same as power on
	Display mode	Auto display mode Button display mode Power-off display mode: display items are the same as button mode
	Display operation	Normal display time is configurable: 1~99s, default is 10s. Button display: Press to wake up and switch to auto display mode without operation in 30s (details refer to display part) Power-off display: press to wake up. LCD displays about 8s and then off.
	Display content	Two display list, details refer to display part
<b>Time of Use (TOU)</b>	TOU	<ul style="list-style-type: none"> <li>- Up to 6 tariffs</li> <li>- 12-day profile table (10-time span per day profile)</li> <li>- 12-week profile table (7 typical days per week profile)</li> <li>- 12 season profile table (1 typical week per season profile)</li> <li>- 100 definable special holidays</li> </ul>
	Clock	≤0.5s/day (in 23°C ,5PPM)
	Daylight saving time	UTC only
	Battery life	10 years battery operation life; Operate for at least 3 years in case of any power failure
<b>Load Profile, Maximum Demand &amp; Billing Data</b>	Load capture period	Capture period is configurable: 1~60 min
	Load profile 1 (energy & demand)	Up to 24 capture object Capture interval: 1~60min, default is 30 min Storage: more than 120 days 30 minutes interval (4800 records)
	Load profile 2 (instantaneous)	Up to 24 capture object Capture interval: 1~60min, default is 30 min Storage: more than 120 days 30 minutes interval (4800 records)
	Maximum demand period	Period is configurable: 1min, 5min, 10 min, 15 min, 30 min, 60 min Sliding number: 1-15
	Billing way	Manually billing: pressing the programming button for over 5s and reset max. demand. Programming billing: billing by PC software and reset, max. demand. Automatically billing: billing automatically on billing days.

	Billing data	<p>Billing data are configurable and can store latest 12 times data.</p> <p>Data capture objects are as follows:</p> <ul style="list-style-type: none"> <li>Billing time</li> <li>Meter number</li> <li>Import/Export active tariff energy of total and split</li> <li>Import/Export reactive tariff energy of total and split</li> <li>Reactive total and split tariff energy of Q1</li> <li>Reactive total and split tariff energy of Q2</li> <li>Reactive total and split tariff energy of Q3</li> <li>Reactive total and split tariff energy of Q4</li> <li>Total import apparent energy</li> <li>Total export apparent energy</li> <li>Import/Export active MD and occurrence time of total and split tariff</li> <li>Alarm status</li> <li>Billing times</li> </ul>
<b>Events</b>	Event log	Support latest 100 items at most Details see 2.2.5
	Event operation Parameter setting	Details see 2.2.5
<b>Data Security</b>	Data security	<p>Client users have access to meter:</p> <ul style="list-style-type: none"> <li>Management user (21)</li> <li>Technical user (23)</li> <li>Module management user (22)</li> <li>Upgrade user (20)</li> <li>Read user (16)</li> </ul> <p>Management user, technical user, module management user and upgrade user adopt LN access mode and LLS encryption mode to access the meter, and the secret key of each user is different.</p> <p>Read user can access the meter by LN mode.</p> <p>Please pay attention to the differences of access to data among each user.</p>

## 2.2. Meter function description

### 2.2.1. Energy Metering

#### 2.2.1.1. Metering Method

Import active energy = |+ A1| + |+ A2| + |+ A3| + |- A1| + |- A2| + |- A3|

$$= |+ A1| + |+ A2| + |+ A3|$$

Export active energy = |- A1| + |- A2| + |- A3|

Import reactive energy = |+Ri| + |+Rc|

Export reactive energy = |-Ri| + |-Rc|

(The +Ri is Q1, the +Rc is Q2, the -Ri is Q3, the -Rc is Q4)

The metering method of apparent energy is the same as active metering. Import active energy and apparent energy can be set by sending order.

#### 2.2.1.2. Metering Accuracy

- Active Class 1/Class B
- Reactive Class 2

#### 2.2.1.3. Metering Items

- Import active tariff energy of total and split
- Export active tariff energy of total and split
- Import reactive tariff energy of total and split
- Export reactive tariff energy of total and split
- Total reactive energy of quadrant 4
- Total import apparent energy
- Total export apparent energy
- Total import/export active energy of split-phase
- Total import/export reactive energy of split-phase

## 2.2.2. Energy and Demand Load Profiles

### 2.2.2.1. Demand Recording Mode

Works in block mode, where the periodic time is 30 min.

### 2.2.2.2. Maximum Demand Reset

- Manually billing: pressing the programming button for over 5s and reset current maximum demand.
- Programming billing: billing by PC software and reset current maximum demand.
- Automatic billing: billing automatically on billing days.

Where, **demand** refers to the average power consumption of the user during the period; **maximum demand** refers to the maximum demand during billing period; and the **cumulative maximum demand** is the maximum demand during the whole working period.

### 2.2.2.3. Billing Items

- Import/Export active MD and occurrence time of total and split tariff

- Import/Export reactive MD and occurrence time of total and split tariff
- Total import apparent MD and occurrence time
- Total export apparent MD and occurrence time

#### **2.2.2.4. Energy Profile**

Stores 6 months of half-hourly data of:

- Cumulative active import energy (kWh)
- Cumulative active export energy (kWh)

#### **2.2.2.5. Available Instantaneous Values**

- Voltage (A/B/C)
- Current (A/B/C)
- Power factor (Total/A/B/C)
- Active power (Total)
- Import active power (A/B/C)
- Export active power (A/B/C)
- Reactive power (Total)
- Import reactive power (A/B/C)
- Export reactive power (A/B/C)
- Apparent power (Total/A/B/C)
- Power grid frequency
- Voltage angle (AB/AC)
- Voltage and current angle (A/B/C)





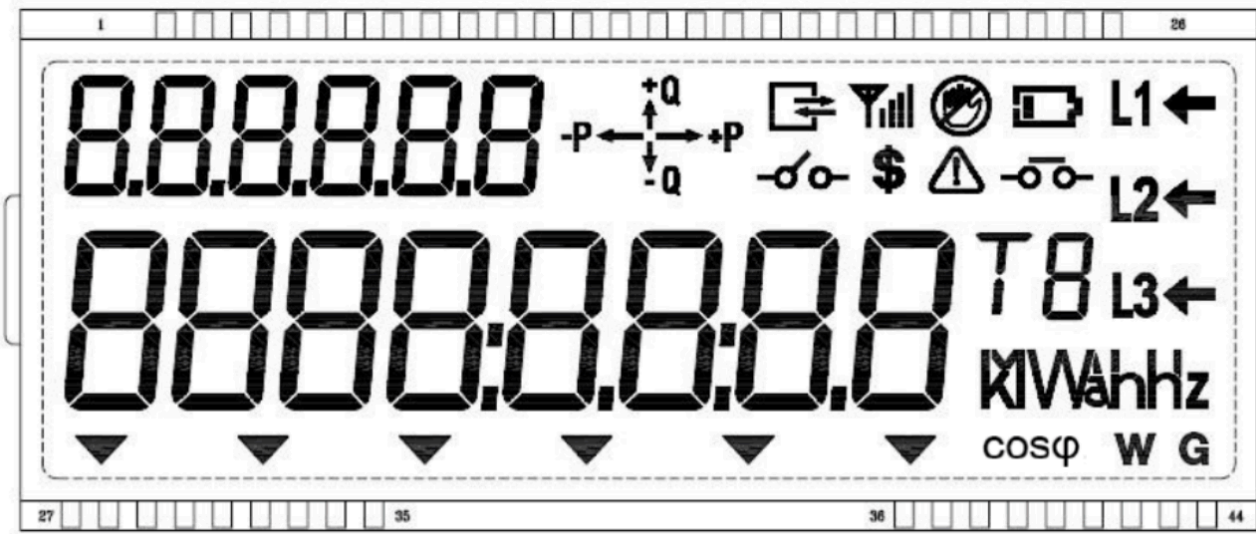

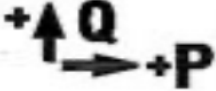

### 2.2.3. Display

#### 2.2.3.1. LCD Full Display

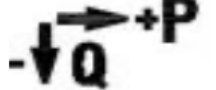

#### 2.2.3.2. LCD Status and Alarm Display

	Value
	OBIS Code
	Communication indicator – The meter is communicated if displayed
	Units (kWh, kVArh, VA, V, A, W)
	Alarms or warnings. From left to right: <ul style="list-style-type: none"> <li>• 1st = None/Unused</li> <li>• 2nd = meter terminal cover open</li> <li>• 3rd = top meter cover open</li> <li>• 4th = magnetic influence</li> <li>• 5th = None/Unused</li> <li>• 6th = reverse phase sequence</li> </ul>
	Phase 1 status: <ul style="list-style-type: none"> <li>• Displayed = phase 1 is normal</li> <li>• Flashing = over-voltage or under-voltage</li> <li>• Not displayed = phase lost</li> </ul>

<b>L2</b>	<p>Phase 2 status:</p> <ul style="list-style-type: none"> <li>• Displayed = phase 2 is normal</li> <li>• Flashing = over-voltage or under-voltage</li> <li>• Not displayed = phase lost</li> </ul>
<b>L3</b>	<p>Phase 3 status:</p> <ul style="list-style-type: none"> <li>• Displayed = phase 3 is normal</li> <li>• Flashing = over-voltage or under-voltage</li> <li>• Not displayed = phase lost</li> </ul>
	Q1: active import and reactive import power
	Q2: active export and reactive import power
	Q3: active export and reactive export power
	Q4: active export and reactive export power
	Low-battery alarm
	Current-reversed event
	Power control disconnection alarm
	Temper indicator: displayed when the top cover or terminal cover is open
	<p>Relay status:</p> <ul style="list-style-type: none"> <li>• Displayed = relay is disconnected remotely</li> <li>• Flashing = relay needs manual closing</li> </ul>

### 2.2.3.3. Display Time

- Auto-scroll display: 10 seconds
- Manual button display: the screen will keep in this mode for 30s and turn to auto display mode if there is no more button display
- Power failure display: when there is power failure, the LCD will not display until pressing the button, and it can keep display for 12s if there is no more button pressing

### 2.2.3.4. Display Contents

Auto display mode and button display mode are divided into two scroll display lists. Each list can support 60 items at most. Pressing button to wake up button display list, and LCD will switch to scroll display list after 30s.

Available display contents are as follows (configurable):

OBIS Code	Description	Unit
1.8.0	Total import active energy (*)	kWh
2.8.0	Total export active energy (*)	kWh
3.8.0	Total import reactive energy (*)	kVArh
4.8.0	Total export reactive energy (*)	kVArh
9.8.0	Total import apparent energy (*)	kVAh
10.8.0	Total export apparent energy (*)	kVAh
21.8.0	Total import active energy of Phase 1 (*)	kWh
41.8.0	Total import active energy of Phase 2 (*)	kWh
61.8.0	Total import active energy of Phase 3 (*)	kWh
22.8.0	Total export active energy of Phase 1 (*)	kWh
42.8.0	Total export active energy of Phase 2 (*)	kWh
62.8.0	Total export active energy of Phase 3 (*)	kWh
21.8.0	Total import reactive energy of Phase 1 (*)	kVArh
41.8.0	Total import reactive energy of Phase 2 (*)	kVArh
61.8.0	Total import reactive energy of Phase 3 (*)	kVArh
22.8.0	Total export reactive energy of Phase 1 (*)	kVArh
42.8.0	Total export reactive energy of Phase 2 (*)	kVArh
62.8.0	Total export reactive energy of Phase 3 (*)	kVArh
32.7.0	Voltage of Phase 1	V
52.7.0	Voltage of Phase 2	V
72.7.0	Voltage of Phase 3	V
31.7.0	Current of Phase 1 (*)	A

51.7.0	Current of Phase 2 (*)	A
71.7.0	Current of Phase 3 (*)	A
14.7.0	Frequency	Hz
1.7.0	Import active power (*)	kW
21.7.0	Import active power of Phase 1 (*)	kW
41.7.0	Import active power of Phase 2 (*)	kW
61.7.0	Import active power of Phase 3 (*)	kW
23.7.0	Import reactive power of Phase 1 (*)	kVAr
43.7.0	Import reactive power of Phase 2 (*)	kVAr
63.7.0	Import reactive power of Phase 3 (*)	kVAr
9.7.0	Import apparent power (*)	kVA
29.7.0	Import apparent power of Phase 1 (*)	kVA
49.7.0	Import apparent power of Phase 2 (*)	kVA
69.7.0	Import apparent power of Phase 3 (*)	kVA
22.7.0	Export active power of Phase 1 (*)	kW
42.7.0	Export active power of Phase 2 (*)	kW
62.7.0	Export active power of Phase 3 (*)	kW
24.7.0	Export reactive power of Phase 1 (*)	kVAr
44.7.0	Export reactive power of Phase 2 (*)	kVAr
64.7.0	Export reactive power of Phase 3 (*)	kVAr
13.7.0	Power factor	
13.7.0	Power factor of Phase 1	
13.7.0	Power factor of Phase 2	
13.7.0	Power factor of Phase 3	
0.9.1	Time (UTC)	hh:mm:ss
0.9.2	Date (UTC)	DD-MM-YY
C.1.0	Meter number	12 digits
0.4.2	CT ratio	A/A

(\*) CT ratio not included in value

### 2.2.4. Clock

- Auto-switch of leap year
- Set to UTC
- Clock error is <0.5sec/day (in 23°C, 5ppm)
- Built-in battery life: 10 years battery operation life;
  - Operates for at least 3 years in case of any power failure.

### 2.2.5. Events

#### 2.2.5.1. Standard Events

Records the latest 100 events, and the contents are as follows:

- Meter reset (upon power off, battery removal, or discharging)
- Firmware updated successfully
- Programming event
- Start of battery under voltage
- End of battery under voltage
- Total event reset
- Password error
- Clock setting

#### 2.2.5.2. Power Events

Records the latest 100 events, and the contents are as follows:

- Phase 1 reversed current start
- Phase 1 reversed current end
- Phase 2 reversed current start
- Phase 2 reversed current end
- Phase 3 reversed current start
- Phase 3 reversed current end
- Phase 1 losing start
- Phase 1 losing end
- Phase 2 losing start
- Phase 2 losing end
- Phase 3 losing start
- Phase 3 losing end
- Phase 1 current losing start
- Phase 1 current losing end
- Phase 2 current losing start
- Phase 2 current losing end
- Phase 3 current losing start
- Phase 3 current losing end
- Phase 1 with current and no voltage start
- Phase 1 with current and no voltage end
- Phase 2 with current and no voltage start
- Phase 2 with current and no voltage end
- Phase 3 with current and no voltage start
- Phase 3 with current and no voltage end
- Phase 1 over voltage 1/2 start
- Phase 1 over voltage 1/2 end
- Phase 2 over voltage 1/2 start
- Phase 2 over voltage 1/2 end
- Phase 3 over voltage 1/2 start
- Phase 3 over voltage 1/2 end
- Phase 1 under voltage 1/2 start
- Phase 1 under voltage 1/2 end
- Phase 2 under voltage 1/2 start
- Phase 2 under voltage 1/2 end
- Phase 3 under voltage 1/2 start
- Phase 3 under voltage 1/2 end
- Unbalanced current start
- Unbalanced current end
- Unbalanced voltage start
- Unbalanced voltage end
- Reversed phase sequence start
- Reversed phase sequence end
- Reversed polarity start
- Reversed polarity end
- Power off start
- Power off end
- Neutral line losing start
- Neutral line losing end

### 2.2.5.3. Tamper Events

Records the latest 100 tampering events, and the contents are as follows:

- Open terminal cover start
- Open terminal cover end
- Strong magnetic influence start
- Strong magnetic influence end
- Open top cover start
- Open top cover end

## 2.3. Communication

### 2.3.1. Optical Port

- Communication rate range: 1200~19200bps
- Baud rate: 300bps
- Communication protocol: IEC62056-21 E mode, HDLC protocol
- Configuration and data access can be done from manufacturer PC software
  - Returns configurable data including current energy, demand energy, historical energy, real-time information and clock settings
  - Returns stored events

### 2.3.2. Remote Communication

All Glow Meters come with Wi-Fi and mobile connectivity (NB-IoT/LTE-M/2G) for remote two-way communication with the meter.

Communication between the meter and our servers over Wi-Fi happens every ~10 seconds. If Wi-Fi network is not available or configured, the meter will try to connect to a mobile network. When connected to the cellular network, the meter sends and receives data every 5 mins.

The functionalities available with remote connection are:

- Configure access to any instantaneous value present in section 2.2.2.5.
  - Default: active import energy (kWh) and maximum demand (kVA)
- Retrieve historical half-hourly energy profile (refer to section 2.2.2.4)
- Set CT ratio
- Update firmware
- Access temper and disconnection events

#### 2.3.2.1. Wi-Fi Technical Details

- 2.4 GHz 802.11 b/g/n
- Network time via NTP
- WPA2
- TLS 1.2
- Internal antenna
- Secure over the air (OTA) software upgrades

#### 2.3.2.2. LTE-M and NB-IoT Technical Details

- Global connectivity

- External antenna
- Cat M1: B1/ 2/ 3/ 4/ 5/ 8/ 12/ 13/ 18/ 19/ 20/ 25/ 26/ 27/ 28/ 66/ 85
- Cat NB2: B1/ 2/ 3/ 4/ 5/ 8/ 12/ 13/ 18/ 19/ 20/ 25/ 28/ 66/ 71/ 85

### 2.3.2.3. GPRS (2G) Technical Details

- Used as back-up when LTE-M or NB-IoT are unavailable
- Global connectivity
- External antenna
- 85.6 - 107 kbps

### 2.3.3. Bluetooth

Includes Bluetooth capabilities that allows connecting locally to the meter with the Connect App – a mobile application for easy local commissioning and diagnostics.

The functionalities available over Bluetooth are:

- Setting Wi-Fi credentials
- Checking connectivity status for Wi-Fi and cellular network
- Set meter IDs
- Check hardware and firmware details
- Retrieve historical data from meter

#### 2.3.3.1. Technical Details

- BLE 5 Protocol
- Radio output: +3dBm maximum
- Secure configuration, firmware updates and AMR

## 3. Commissioning

---

After the meter is wired up and connected to the circuit, the meter needs to be commissioned. This process is done through our Connect App (mobile application) and Glow Monitor (web application).

Scan the QR code below for more information on Commissioning:

